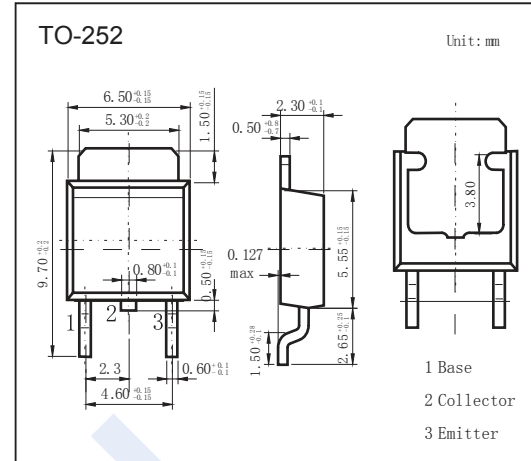

PNP Transistors

2SB962-Z

■ Features

- Low collector to emitter saturation voltage $V_{CE(sat)}$.

■ Absolute Maximum Ratings $T_a = 25^\circ\text{C}$

Parameter	Symbol	Rating	Unit
Collector - Base Voltage	V_{CBO}	-40	V
Collector - Emitter Voltage	V_{CEO}	-30	
Emitter - Base Voltage	V_{EBO}	-5	
Collector Current - Continuous	I_C	-3	A
Collector current -Pulse	I_{CP}	-6	
Collector Power Dissipation (Note.1)	P_C	2	W
Junction Temperature	T_J	150	$^\circ\text{C}$
Storage Temperature range	T_{stg}	-55 to 150	

Note.1: $PW \leq 10\text{ms}$, Duty Cycle $\leq 50\%$

■ Electrical Characteristics $T_a = 25^\circ\text{C}$

Parameter	Symbol	Test Conditions	Min	Typ	Max	Unit
Collector- base breakdown voltage	V_{CBO}	$I_C = -100 \mu\text{A}$, $I_E = 0$	-40			V
Collector- emitter breakdown voltage	V_{CEO}	$I_C = -1 \text{mA}$, $I_B = 0$	-30			
Emitter - base breakdown voltage	V_{EBO}	$I_E = -100 \mu\text{A}$, $I_C = 0$	-5			
Collector-base cut-off current	I_{CBO}	$V_{CB} = -30\text{V}$, $I_E = 0$			-10	μA
Emitter cut-off current	I_{EBO}	$V_{EB} = -4\text{V}$, $I_C = 0$			-1	
Collector-emitter saturation voltage	$V_{CE(sat)}$	$I_C = -2 \text{A}$, $I_B = -200\text{mA}$ (Note.1)		-0.3	-0.5	V
Base - emitter saturation voltage	$V_{BE(sat)}$	$I_C = -2 \text{A}$, $I_B = -200\text{mA}$ (Note.1)		-1	-2	
DC current gain	$h_{FE(1)}$	$V_{CE} = -2\text{V}$, $I_C = -20\text{mA}$ (Note.1)	30	150		
	$h_{FE(2)}$	$V_{CE} = -2\text{V}$, $I_C = -1 \text{A}$ (Note.1)	60	160	400	
Collector output capacitance	C_{ob}	$V_{CB} = -10\text{V}$, $I_E = 0$, $f = 1\text{MHz}$		55		pF
Transition frequency	f_T	$V_{CE} = -5\text{V}$, $I_E = 100\text{mA}$		80		MHz

Note.1: Pulsed: $PW \leq 350\mu\text{s}$, Duty Cycle $\leq 2\%$

■ Classification of $h_{FE(2)}$

Type	2SB962-Z-R	2SB962-Z-Q	2SB962-Z-P	2SB962-Z-E
Range	60-120	100-200	160-320	200-400

PNP Transistors

2SB962-Z

■ Typical Characteristics

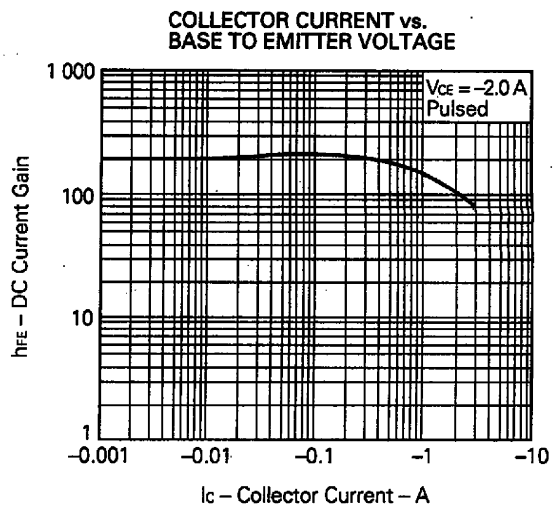
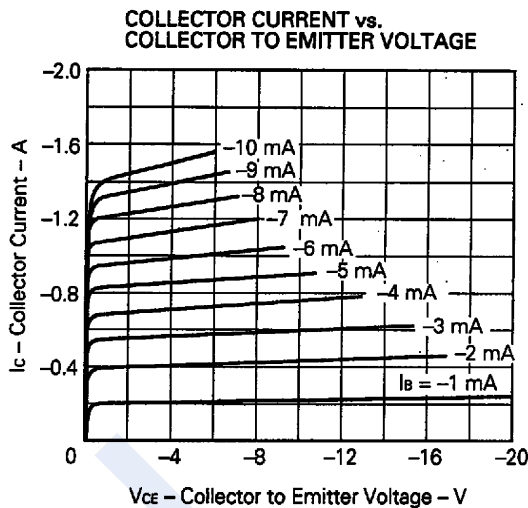
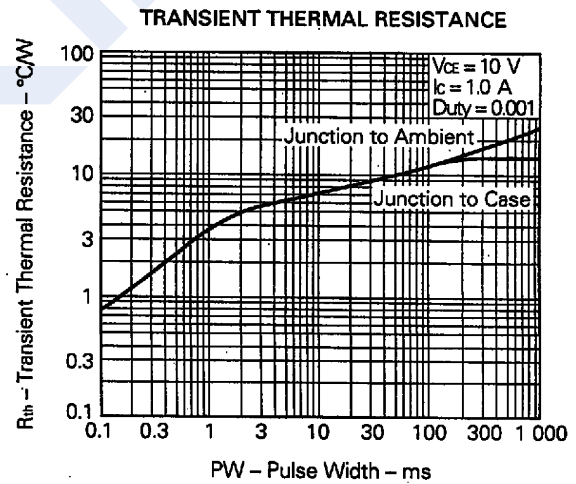
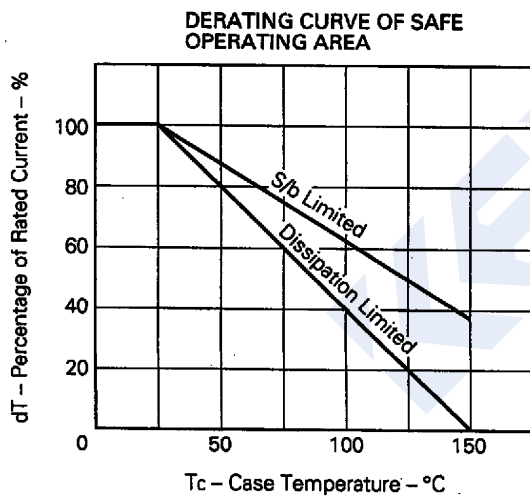
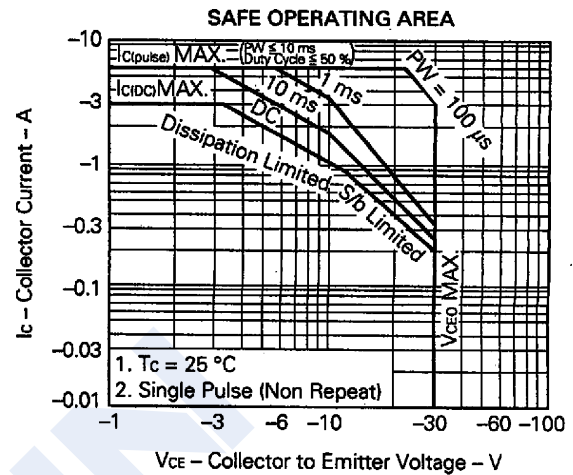
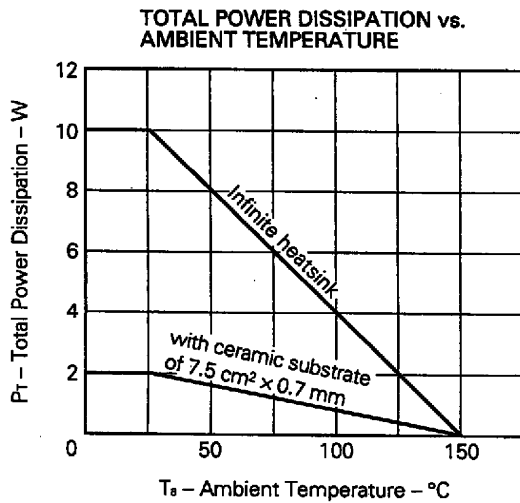

PNP Transistors

2SB962-Z

■ Typical Characteristics

